

CLARIFIERS

 defender[®]
W-Tank[®]

SOLIDS SETTLING
WATER CLARIFICATION

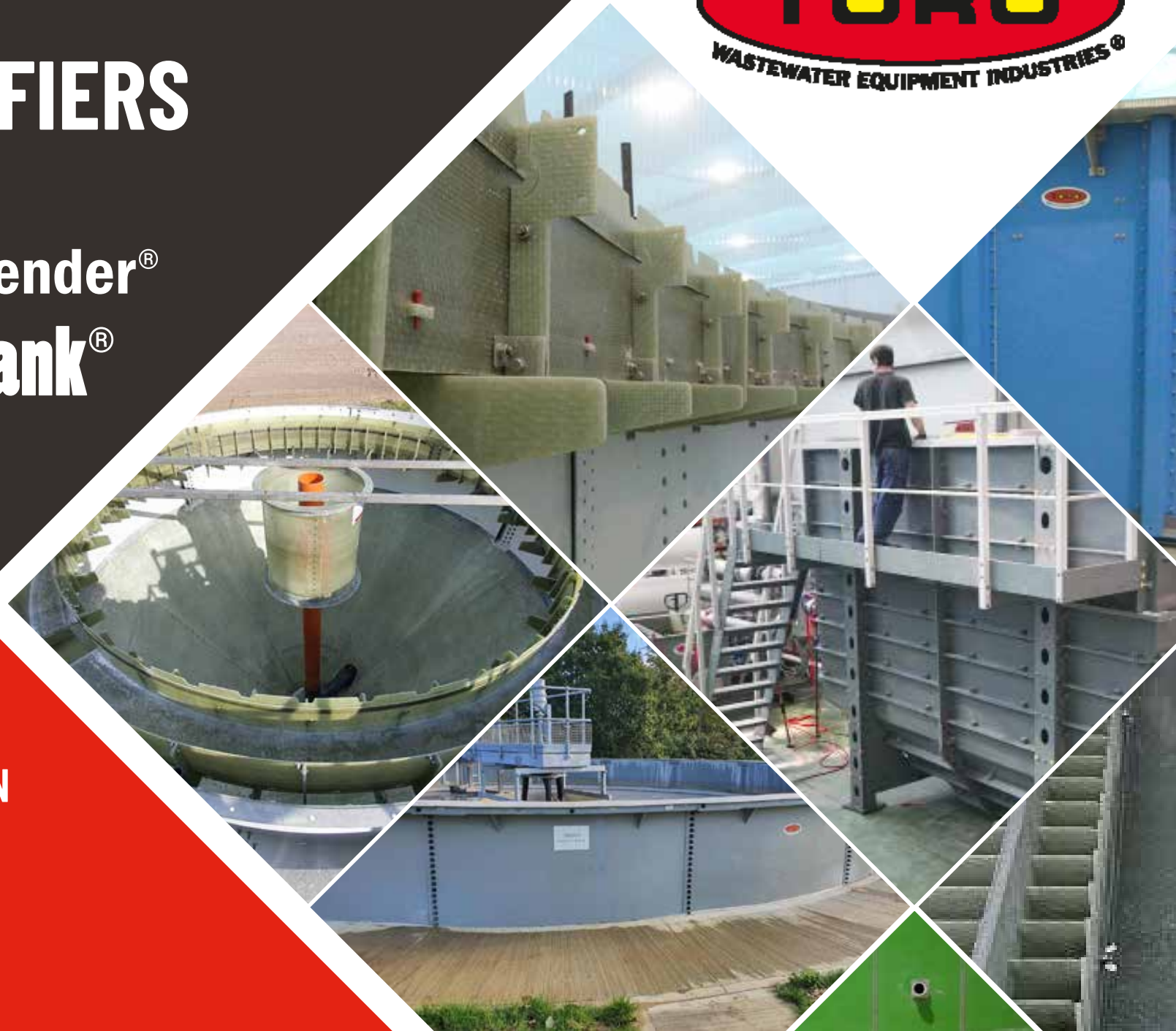

Process description

The function of the **clarifier** is to separate the semi-heavy and heavy elements in suspension (sands, clays, silts), which are carried by the water and which damage the subsequent treatment, generating deposits in the hydraulic conduits, pipes and channels, abrasion in pump impellers and equipment.

PROCESS

Settling is the physical separation of total suspended solids and water. The solids settle by gravity, with the sludge falling to the bottom and the water exiting through the top weir located in the centre or at the perimeter.

The use of coagulant and flocculant helps to improve separation.

From Toro we recommend the use of chambers for this purpose, instead of flocculators.

WHY LAMELLAS?

The lamellas are used to enlarge the settling surface.

They can only be used when the sludge is inorganic, as biological sludge would stick to them and end up collapsing.

In addition, thanks to their design, a homogeneous distribution is achieved along all the lamellas.

DEFENDER® LAMELLAR CLARIFIER

- Mineral solids
- From 2m² to 199m²

W-TANK® LAMELLAR CLARIFIER

- Mineral solids
- From 116m² to 837 m²

W-TANK® STATIC CLARIFIER

- Mineral solids
- From 15m² to 80m²

W-TANK® CIRCULAR CLARIFIER

- Mineral solids
- From 15m² to 1139m²

LAMELLAR
CLARIFIER



LAMELLAR
CLARIFIER



W-Tank®



STACTIC
CLARIFIER



W-Tank®



CIRCULAR
CLARIFIER



W-Tank®



Clarifier | Lamellar Defender®

Saves installation time as no concrete slab is required. Its compact design means that on-site assembly is not necessary. In addition, it can be containerised or on a platform.

SUPPLY KIT

- Vat.
- Lamellar.
- Outlet spillway.
- Connection flanges.
- Metal/GRP structure.

Optional:

- Ladders and platform.
- Bottom purge.



Mineral
solids



From 2m²
to 199m²



		SERIE S		SERIE M		SERIE L	
	Lamella spacing	DCL 5	DCL 10	DCL 20	DCL 30	DCL 60	DCL 90
Projected usable area (m ²)	50	4,0	9,4	17,5	45,1	86,7	130,1
	40	4,8	11,1	21,2	54,6	104,9	157,8
Clean water flow rate m ³ /h	30	6,09	14,5	26,9	69,4	133,5	200,3
	m ³ /h	5	10	20	30	60	90
Equipment dimensions	Altura (h)	950	2.000	2.000	2.300	2.300	2.300
	Longitud (l)	2.400	3.200	4.300	4.700	7.700	10.700
	Anchura (w)	1.600	1.300	1.300	2.070	2.070	2.070

APPLICATIONS

The lamellar clarifier is used in industries that work with easily decantable materials and in drinking water treatment processes.

- Pre-treatment for drinking water.
- Precipitation of metals
- Industrial applications.
- Mining / quarrying / drilling / fracking industry.

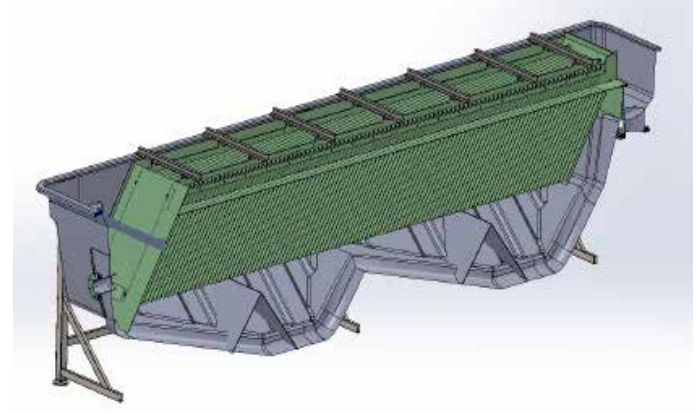
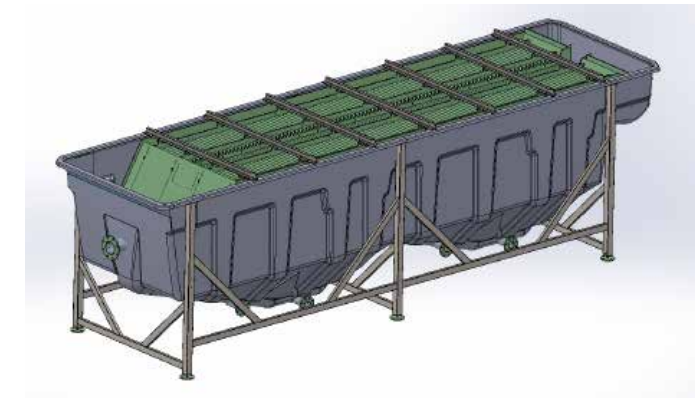

Clarifier | Lamellar W-Tank®

Designed for large flows, the lamellar W-Tank® will save us the concrete funnel slab, the operating costs, and offers us an enlarged decantation surface thanks to the lamella packs.

It also has a coagulation-flocculation chamber within its equipment.

SUPPLY KIT

- Plates.
- Manhole.
- Screws - washers - nuts - gaskets.
- Lamellar packages
- Access stairs
- Gasket with concrete base and sealing primer.
- Assembly instructions.
- Technical data sheet and specifications.



Mineral
solids



From 2m²
to 199m²

W-TANK® LAMELLA DECANTER					
	Diameter (mm)	Height (mm)	Plate spacing (mm)	Decanting surface (m ²)	Flow m ³ /h
N8	5,8	4	57	115	103
N9	6,5	4	57	137	124
N10	7,2	4	57	185	160
N11	7,9	4	57	221	198
N12	8,6	4	57	284	255
N13	9,4	4	57	338	304
N14	10,1	4	57	405	365
N15	10,8	4	57	459	413
N16	11,5	4	57	510	459
N17	12,3	4	57	635	571
N18	13	4	57	702	632
N19	13,7	4	57	779	701
N20	14,4	4	57	837	753

APPLICATIONS

The lamellar clarifier is used in industries that work with easily decantable materials and in drinking water treatment processes.

- Designed for high flow rates.
- Mining industry.
- Building materials industry.
- Industrial applications

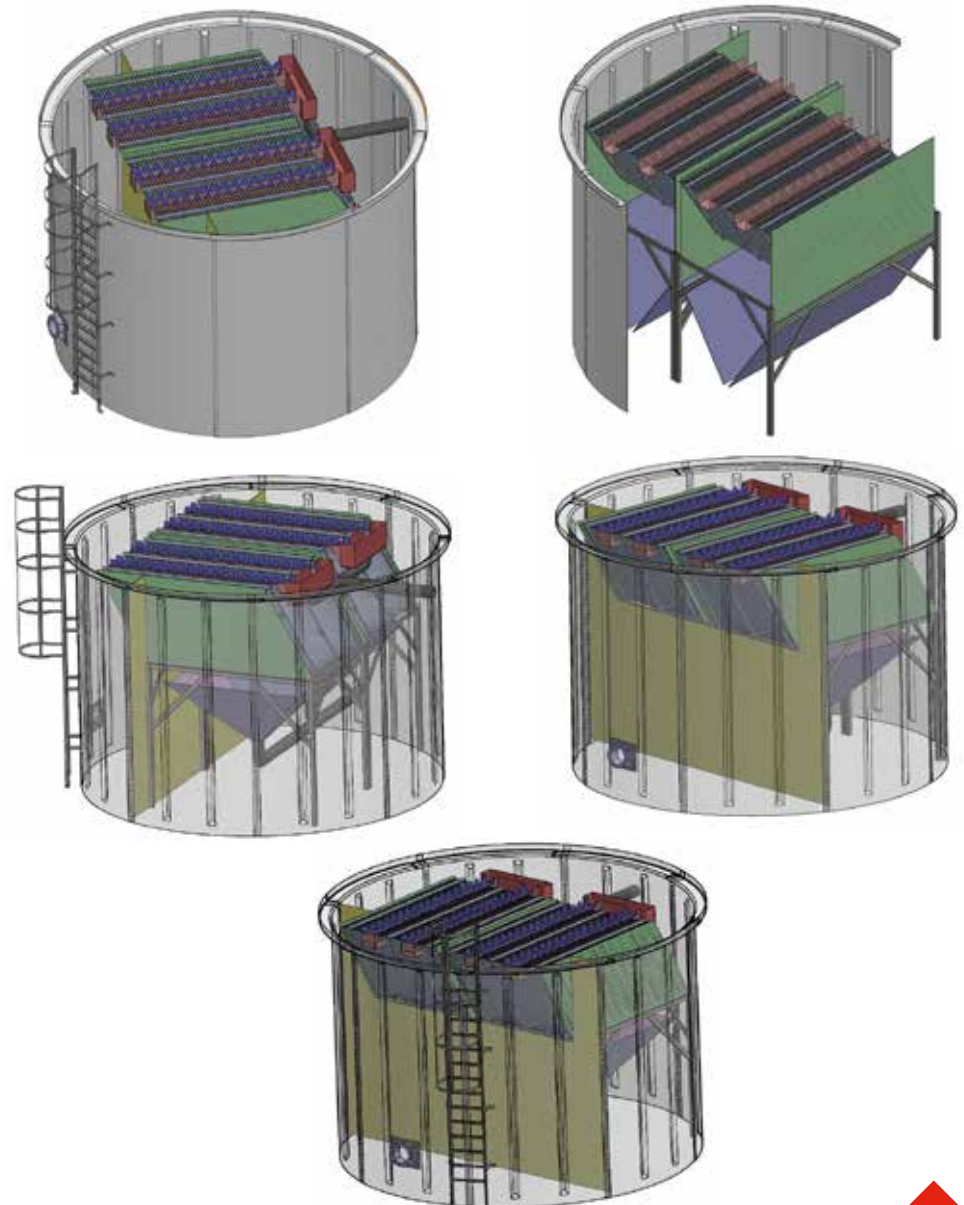

Clarifier | Static W-Tank[®]

It is a good option for smaller flows.

It saves a lot of installation time as it is not necessary to make the floor in a concrete funnel.

SUPPLY KIT

- Plates.
- GRP funnel.
- Manhole.
- Screws - washers - nuts - gaskets.
- Access ladders
- Joint with concrete base and sealing primer.
- Assembly instructions.
- Technical data sheet and specifications.



Biological
solid



From 15m²
to 80m²



NOMINATION		SPECIFICATIONS			
		Outer diameter	High	Surface	Q Step at 0.3m/h
		m	m	m ²	m ³ /h
W-Tank [®]	D.E. H3 D4,3 N6	4,3	3	15	4
W-Tank [®]	D.E. H3 D5,1 N7	5,1	3	20	15
W-Tank [®]	D.E. H3 D5,8 N8	5,8	3	26	20
W-Tank [®]	D.E. H3 D6,5 N9	6,5	3	33	26
W-Tank [®]	D.E. H3 D7,4 N10	7,4	3	43	33
W-Tank [®]	D.E. H3 D7,9 N11	7,9	3	49	43
W-Tank [®]	D.E. H3 D8,6 N12	8,6	3	58	49
W-Tank [®]	D.E. H3 D9,4 N13	9,4	3	69	58
W-Tank [®]	D.E. H3 D10,1 N14	10,1	3	80	69

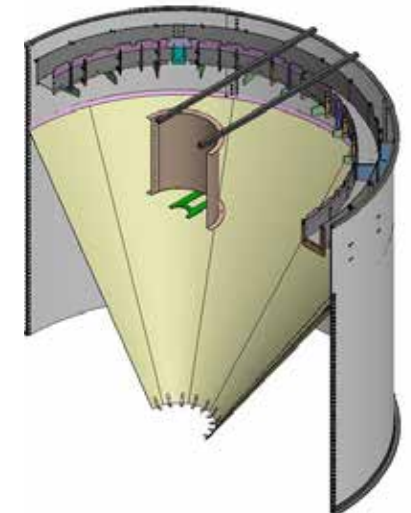
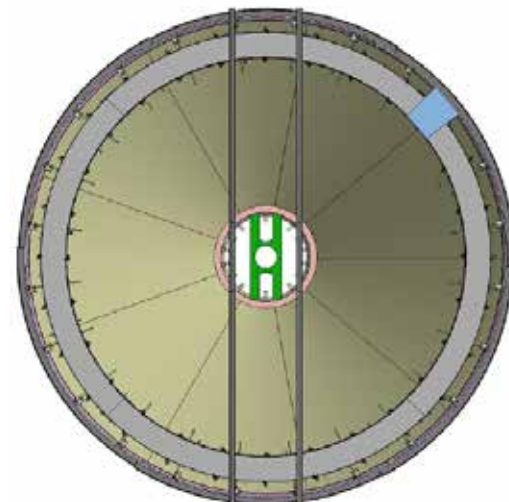
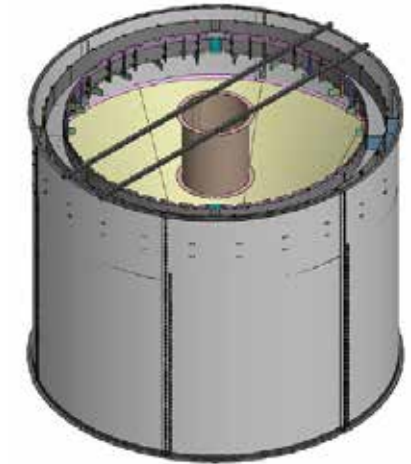
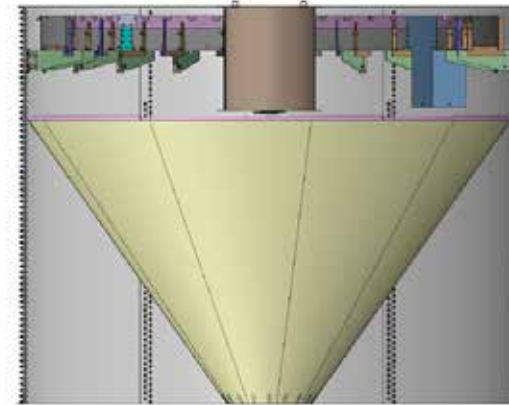

APPLICATIONS

The lamellar clarifier is used in industries that work with easily decantable materials and in drinking water treatment processes.

- Drinking water pre-treatment.
- Water reuse.
- Primary and secondary decanting.

Clarifier | Circular W-Tank[®]

This is the circular W-Tank[®] we have always relied on.

It requires the construction of a funnel-shaped concrete floor and underground pipes to purge the sludge.

This equipment has a scraper bridge to facilitate the decantation of solids.

SUPPLY KIT

- Plates.
- Manhole.
- Screws - washers - nuts - gaskets.
- Joint with concrete base and sealing primer.
- Assembly instructions.
- Technical data sheet and specifications.
- Conformity plan, standard slab construction plan, anchoring and sealing.



Biological
solid



From 15m²
to 1.139m²



Technical Specifications | Circular Clarifier

PLATES	CLARIFIER SURFACE FOR HEIGHT IN METRES												
	Ud.	H=2				H=3				H=4			
		Volume	Ø	Surface	Bridge weight	Volume	Ø	Superface	Bridge weight	Volume	Ø	Superface	Bridge weight
	m ³	m	m ²	kg	m ³	m	m ²	kg	m ³	m	m ²	kg	
6	29	4,3	15	875	44	4,3	15	900	59	4,3	15	925	
7	41	5,1	20	950	61	5,1	20	975	82	5,1	20	1.000	
8	52	5,8	26	1.050	78	5,8	26	1.075	104	5,8	26	1.100	
9	66	6,5	33	1.100	99	6,5	33	1.150	132	6,5	33	1.200	
10	82	7,2	41	1.200	122	7,2	41	1.250	163	7,2	41	1.300	
11	99	7,9	49	1.250	148	7,9	49	1.300	197	7,9	49	1.475	
12	117	8,6	59	1.350	176	8,6	59	1.400	235	8,6	59	1.450	
13	138	9,4	69	1.425	207	9,4	69	1.450	276	9,4	69	1.550	
14	160	10,1	80	1.500	240	10,1	80	1.550	320	10,1	80	1.600	
15	184	10,8	92	1.575	275	10,8	92	1.650	367	10,8	92	1.700	
16	209	11,5	104	1.650	313	11,5	104	1.700	418	11,5	104	1.750	
17	236	12,3	118	1.775	354	12,3	118	1.775	472	12,3	118	1.850	
18	264	13,0	132	1.800	396	13,0	132	1.850	529	13,0	132	1.900	
19	294	13,7	147	1.850	442	13,7	147	1.900	589	13,7	147	1.950	
20	326	14,4	163	1.900	489	14,4	163	1.950	653	14,4	163	2.000	
21	360	15,1	180	1.900	540	15,1	180	1.975	720	15,1	180	2.025	
22	395	15,9	197	1.925	592	15,9	197	2.000	790	15,9	197	2.075	
23	432	16,6	216	1.975	647	16,6	216	2.050	863	16,6	216	2.125	
24	470	17,3	235	2.025	705	17,3	235	2.100	940	17,3	235	2.175	
25	510	18,0	255	2.050	765	18,0	255	2.125	1.020	18,0	255	2.200	
26	551	18,7	276	2.075	827	18,7	276	2.150	1.103	18,7	276	2.225	
27	595	19,5	297	2.100	892	19,5	297	2.175	1.189	19,5	297	2.250	
28	640	20,2	320	2.125	959	20,2	320	2.200	1.279	20,2	320	2.275	
29	686	20,9	343	2.175	1.029	20,9	343	2.250	1.372	20,9	343	2.325	
30	734	21,6	367	2.225	1.101	21,6	367	2.300	1.468	21,6	367	2.375	
31	784	22,3	392	2.275	1.176	22,3	392	2.350	1.568	22,3	392	2.325	
32	835	23,1	417	2.325	1.253	23,1	417	2.400	1.671	23,1	417	2.475	
33	888	23,8	444	2.375	1.333	23,8	444	2.450	1.777	23,8	444	2.525	
34	943	24,5	471	2.425	1.415	24,5	471	2.500	1.886	24,5	471	2.575	
35	999	25,2	499	2.475	1.499	25,2	499	2.550	1.999	25,2	499	2.625	
36	1.057	25,9	528	2.500	1.586	25,9	528	2.600	2.115	25,9	528	2.700	
37	1.117	26,7	558	2.600	1.675	26,7	558	2.700	2.234	26,7	558	2.800	
38	1.178	27,4	589	2.700	1.767	27,4	589	2.800	2.356	27,4	589	2.900	
39	1.241	28,1	620	2.750	1.861	28,1	620	2.900	2.482	28,1	620	3.000	
40	1.305	28,8	652	2.850	1.958	28,8	652	2.950	2.610	28,8	652	3.050	
41	1.371	29,5	685	2.950	2.057	29,5	685	3.050	2.743	29,5	685	3.150	
42	1.439	30,3	719	3.050	2.159	30,3	719	3.150	2.878	30,3	719	3.250	
43	1.508	31,0	754	3.125	2.263	31,0	754	3.200	3.017	31,0	754	3.325	
44	1.579	31,7	789	3.200	2.369	31,7	789	3.300	3.159	31,7	789	3.400	
45	1.652	32,4	826	3.250	2.478	32,4	826	3.350	3.304	32,4	826	3.450	
46	1.726	33,2	863	3.325	2.589	33,2	863	3.425	3.452	33,2	863	3.525	
47	1.802	33,9	901	3.375	2.703	33,9	901	3.500	3.604	33,9	901	3.600	
48	1.880	34,6	939	3.450	2.819	34,6	939	3.550	3.759	34,6	939	3.650	
50	1.954	35,3	976	3.600	2.931	35,3	976	3.700	3.908	35,3	976	3.800	
51	2.033	36,0	1.016	3.700	3.049	36,0	1.016	3.850	4.066	36,0	1.016	3.900	
52	2.113	36,7	1.056	3.800	3.170	36,7	1.056	3.925	4.227	36,7	1.056	4.050	
53	2.195	37,4	1.097	3.850	3.293	37,4	1.097	3.975	4.391	37,4	1.097	4.100	
54	2.279	38,1	1.139	3.900	3.419	38,1	1.139	4.025	4.558	38,1	1.139	4.150	

*Volume table for plate width: 2,420 mm

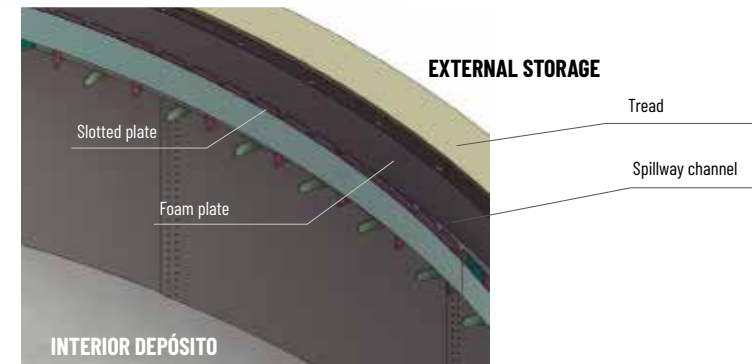
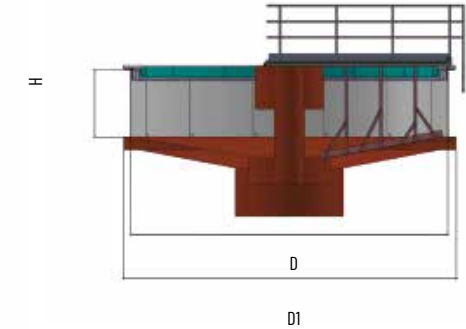
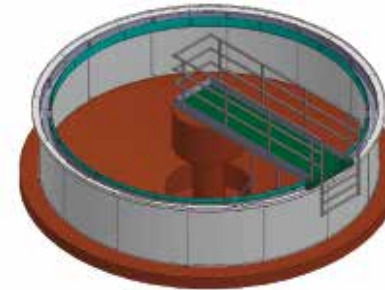

APPLICATIONS

The lamellar clarifier is used in industries that work with easily decantable materials and in drinking water treatment processes.

- Water treatment plants.
- Water reuse.
- Mining industry.
- Construction materials industry.
- Industrial applications.



Fábrica Villavaquerín - Valladolid

WORLD REFERENCES

- Algeria
- Argentina
- Australia
- Austria
- Belgium
- Brazil
- Bulgaria
- Canada
- Chile
- China
- Colombia
- Costa Rica
- Croatia
- Dominican Republic
- Ecuador
- Egypt
- Estonia
- Finland
- France
- Germany
- Greece
- Guatemala
- Holland
- Hungary
- Indonesia
- Iran
- Ireland
- Israel
- Italy
- Japan
- Jordan
- Latvia
- Lebanon
- Lithuania
- Luxembourg
- Malaysia
- Mexico
- Montenegro
- Morocco
- Netherlands
- Nicaragua
- Pakistan
- Panama
- Peru
- Philippines
- Poland
- Portugal
- Qatar
- Romania
- Russia
- Saudi Arabia
- Serbia
- Seychelles
- Singapore
- Slovenia
- South Africa
- Spain
- Switzerland
- Thailand
- Trinidad and Tobago
- Tunisia
- Turkey
- UK
- Ukraine
- United Arab Emirates
- United States of America
- Uruguay
- Vietnam

FOUNDED
1989



+34 983 403 047
toro@toroequipment.com
toroequipment.com

FACTORY

Ctra. Nacional VP-3302, km 11
47329 Villavaquerín
Valladolid (Spain)

FACTORY AND OFFICES

C/ Ronda del Sauce 34
47193 La Cistérniga
Valladolid (Spain)



© TORO EQUIPMENT 2021
Clarifiers

